



# Attachment Devices

Operation and selection guide

Horizontal, vertical and inclined systems



## Latchways attachment devices

All the Latchways attachment devices are designed to connect the user, wearing a full body harness, to a ManSafe® cable system.

Common to all devices is the patented starwheel mechanism which rotates freely over intermediate cable supports and around corner brackets without needing to disconnect the unit. This allows hands free operation for the system users.

There are several types of device depending on the application:

### Horizontal use

Transfastener™ and  
Removable Transfastener



### Vertical use

LadderLatch®  
and TowerLatch®



### Inclined use

ClimbLatch™



Other types of attachment device for various applications are available.  
For more details visit [www.latchways.com](http://www.latchways.com).

# Horizontal systems

## Transfastener and Removable Transfastener

- Universal device for use on all Latchways horizontal systems, suitable for both fall restraint and arrest systems.
- Incorporates unique starwheel allowing the unit to pass over cable supports and corners without the need to detach.
- Connects to user at dorsal point.
- Whereas the Transfastener requires a specific entry point, the Removable Transfastener can attach or detach at any safe point.



### Connecting a Transfastener

- 1 A specific entry terminal is required to connect the Transfastener.
- 2 Rest the device onto the entry terminal and push the slipper downwards through the fork of the terminal. The plastic gate will be pushed open to allow this.
- 3 When the slipper has passed underneath the terminal the device can be pulled along the cable.
- 4 With the plastic gate closed, the device is now fully connected and ready for use.

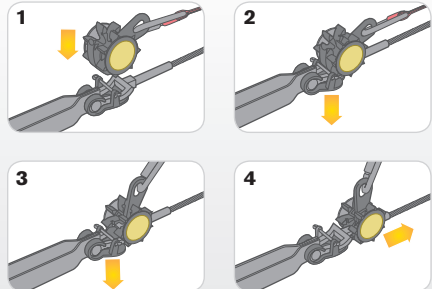

### Connecting a Removable Transfastener

- 1 Slide the link cover over to one side and move the slipper to the same side of the unit.
- 2 Place the unit onto the cable so that the cable is positioned between the two starwheels and is also located within the recess of the link body.
- 3 Move the link body and cover across to the other side of the unit, ensuring that the slipper is fully engaged onto the cable.
- 4 The Removable Transfastener will now hang on the cable and is safe to be attached to.

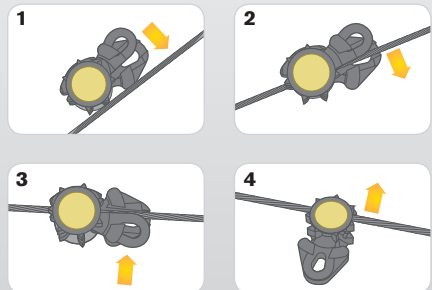

# Vertical systems

## LadderLatch and TowerLatch

- Universal device for use on all Latchways' vertical systems.
- Incorporates unique starwheel allowing the unit to pass over cable supports without need to detach.
- Anti-inversion mechanism so device cannot be connected to cable upside down.
- Connects to user at chest point.
- Able to attach or detach at any safe point of the system.
- In the event of a fall, the unit locks onto the cable and arrests the fall.



### Connecting to a LadderLatch or TowerLatch system

- 1 With the attachment links in the vertical plane, press the release catch on the side of the unit.
- 2 With your other hand, pull the starwheel away from the body of the device.
- 3 Offer the unit up to the cable and position the cable to sit within the cavity of the device body.
- 4 Remove your thumb from the release catch. Allow the starwheel to return to its original position and this will locate the cable correctly within the device.

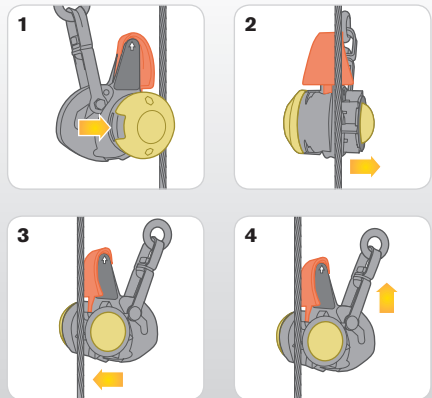

# Vertical/inclined systems

## ClimbLatch

- The ClimbLatch device has many similar features of the LadderLatch and TowerLatch but is designed to also be used on an inclined system – suitable for use between a 0° and 40° incline.
- The ClimbLatch requires a specific entry point on which to attach to the system.



### Connecting to a ClimbLatch system

- 1 A specific entry terminal is required to connect the ClimbLatch unit on to a system. It must be ensured that the ClimbLatch is attached with the arrow indicating the correct direction of movement/incline.
- 2 Hold the device in the vertical plane to open the unit and with the gate of the entry point open, push the slipper downwards through the gate of the entry point.
- 3 When the slipper has passed through the gate, the device can then be pulled along the cable.
- 4 With the gate closed the device is now fully connected and ready for use.

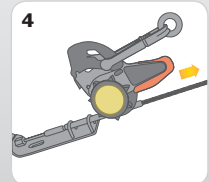
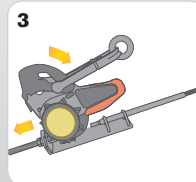
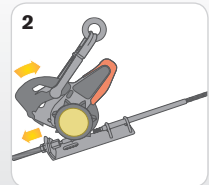
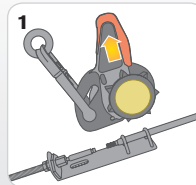





This brochure is prepared for general information only and should not be relied upon in any specific situation without appropriate technical and legislative advice. Whilst every effort has been made to ensure the content of this brochure it may contain inaccuracies or errors, and we expressly exclude liability for any such inaccuracies or errors to the fullest extent permitted by law. If you require any further advice on any of the issues contained herein please contact a member of our technical team.



Certifix, PO Box 133 042 Eastridge, Auckland 1146, New Zealand  
Tel: +64 09 270 2702 Fax: +64 09 625 9924  
Website: [www.certifix.co.nz](http://www.certifix.co.nz)

ManSafe®, LadderLatch® and TowerLatch® are registered trademarks of Latchways plc.  
ClimbLatch™ and Transfastener™ are trademarks of Latchways plc.



Latchways plc, Hopton Park, Devizes, Wiltshire, SN10 2JP, England  
Tel: +44 (0)1380 732700 Fax: +44 (0)1380 732701  
Email: [info@latchways.com](mailto:info@latchways.com) Website: [www.latchways.com](http://www.latchways.com)